

# INSTALLATION GUIDE

## SAFETY & WARNINGS

1. UNLIKE TRADITIONAL DIMMING CONTROLS, WAC Dimmer + Driver REQUIRES UNIQUE WIRING STEPS. READ ALL WARNINGS AND INSTALLATION INSTRUCTIONS THOROUGHLY.
2. Install in accordance with national and local electrical code regulations.
3. This product is intended to be installed and serviced by a qualified, licensed electrician.
4. NEC Code 725.136: Class 1 and Class 2 circuits in same enclosure must be separated by a barrier unless Class 2 circuit conductors are installed in accordance with 725.41 Class 1 Circuits.
5. Only install compatible 24 V Constant Voltage DC fixtures or warranty will be void.
6. Do not modify product beyond instructions or warranty will be void.

## QUICK SPECS / MODELS

	Input	Output	Max Load
EN-D24100-120-R	120VAC	24 VDC	100 W

## SUPPLIED ACCESSORIES

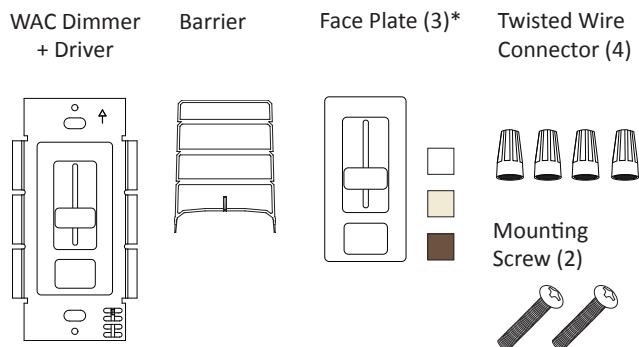

## TOOLS FOR INSTALL



## INSTALLATION

### 1 TURN POWER OFF AT CIRCUIT BREAKER

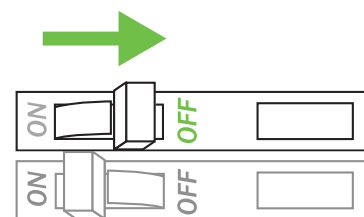
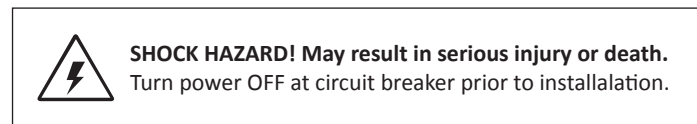

### 2 DETERMINE LOCATION TO INSTALL WAC Dimmer + Driver

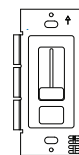

WAC Dimmer + Driver

### 3 REMOVE EXISTING SWITCH (IF NECESSARY)

- a. Remove trim plate and switch mounting screws.
- b. Pull switch from wall.
- c. Identify wires connected to switch and mark wires if desired.
- d. Disconnect wires from switch.

## INSTALLATION CONT.

### 4 CHOOSE FACE PLATE FINISH (IF NECESSARY)

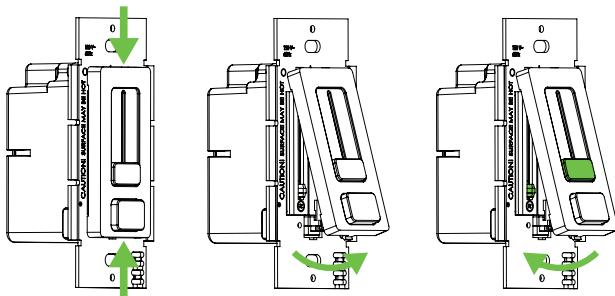

- Gently squeeze top and bottom of face plate.
- Lift face plate from housing.
- Insert replacement face plate into top housing groove. Position housing slider and face plate slider at min brightness (bottom level) and pop on face plate.

### 5 REMOVING FINS (IF NECESSARY)

It's required to break off dimmer fins when ganging multiple dimmers in same wall box.

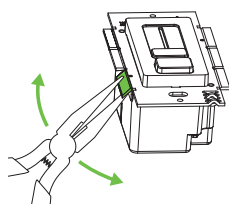

Grip with pliers. Bend back and forth until fin breaks off.

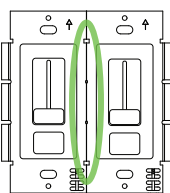

Fins have been removed.

### ZERO LOAD DERATING

Unlike standard high voltage AC controls, removing WAC Dimmer + Driver fins does not reduce the dimmer's maximum wattage rating.

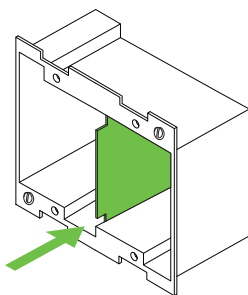

Removeable partition

Install gang boxes that include vertical partitions (available at local electrical distributor) unless Class 2 circuit conductors are installed in accordance with 725.41 Class 1 Circuits.

### 6 ATTACH VOLTAGE PARTITION (BARRIER)

A voltage barrier is provided, which separates high voltage and low voltage wires in the wall box. Attach before mounting.

#### NEC CODE 725.136

Class 1 and Class 2 circuits in same enclosure must be separated by a barrier unless Class 2 circuit conductors are installed in accordance with 725.41 Class 1 Circuits. For example, Non-Metallic (NM) cable is considered a Class 1 circuit conductor. Therefore, if both high voltage and low voltage circuits are installed with NM cable then the voltage barrier is not required for installation.

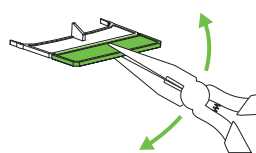
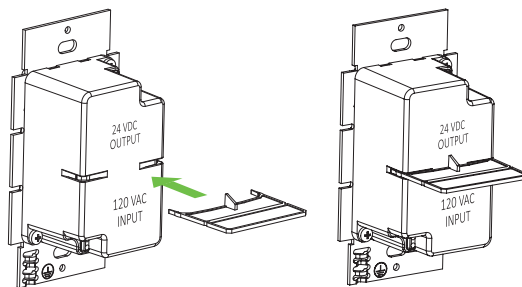

For shallow boxes, barrier can be shortened. Grip with pliers. Bend back and forth until fin breaks off.

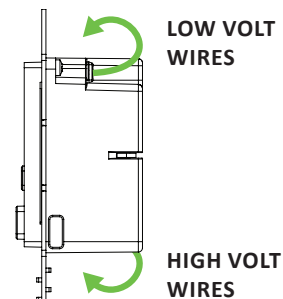

For extra shallow wall boxes it's acceptable to use the dimmer housing as a barrier. Tuck wires on top and bottom sides of dimmer housing.

### 7 WIRE DIMMER

#### SPECIAL WIRING INSTRUCTIONS!

WAC Dimmer + Driver requires unique wiring steps. Read thoroughly.

- Strip wires on dimmer.

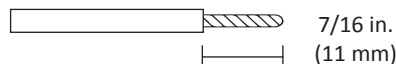

- Wire dimmer. **Ensure main power is OFF.**

- GND (GREEN): To ground wire in box.
- V+ (RED): To low voltage V+.
- V- (BLUE): To low voltage V-.
- N (WHITE): To 120 V Neutral.
- H (BLACK): To 120 V Line Hot.

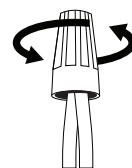

#### WAC Lighting

www.waclighting.com  
Phone (800) 526.2588 • Fax (800) 526.2585

#### Headquarters/Eastern Distribution Center

44 Harbor Park Drive • Port Washington, NY 11050  
Phone (516) 515.5000 • Fax (516) 515.5050

#### Western Distribution Center

1750 Archibald Avenue • Ontario, CA 91760  
Phone (800) 526.2588 • Fax (800) 526.2585

## INSTALLATION CONT.

### 7 CONTINUED.

#### VOLTAGE DROP

See VOLTAGE DROP CHARTS at end of this guide for wire gauge recommendations installed between dimmer and fixture.

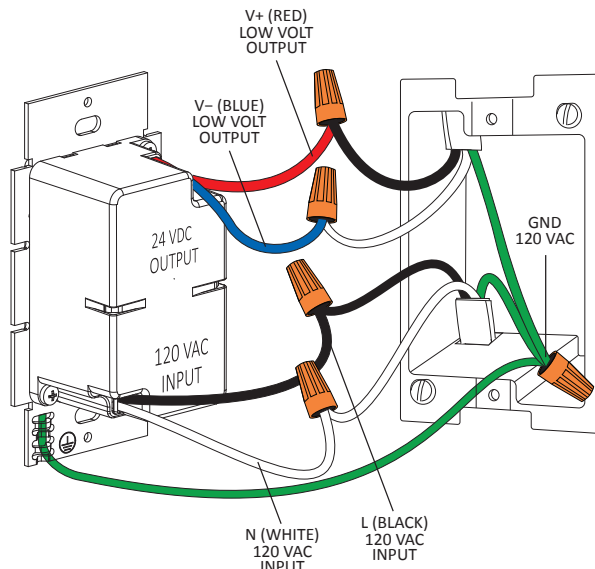

#### SYSTEM DIAGRAM

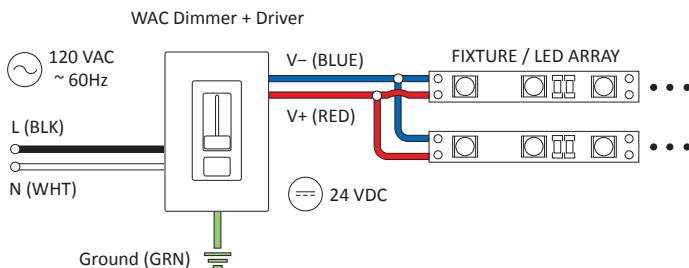

### 8 MOUNT DIMMER TO WALLBOX AND ATTACH TRIM PLATE

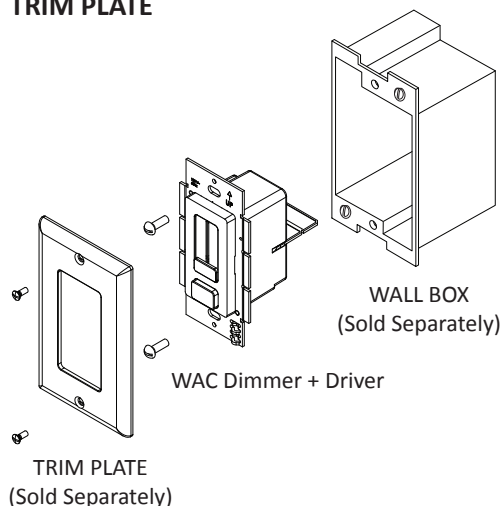

### 9 TURN POWER ON AT THE CIRCUIT BREAKER

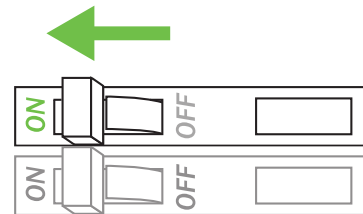

#### SYSTEM WORKING IMPROPERLY?

Turn power OFF at circuit breaker and verify all connections. Review WIRING and TROUBLESHOOTING or call WAC Technical Support at 1.800.526.2588.

#### OPERATION

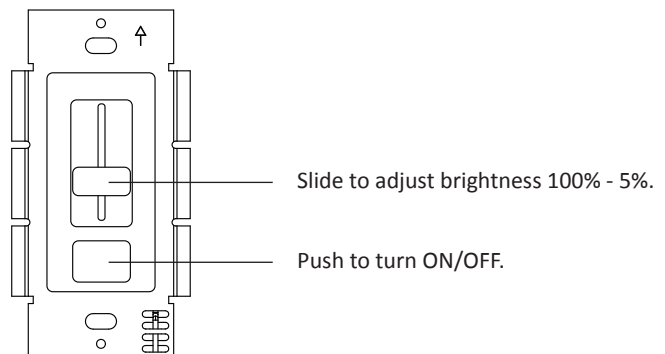

#### TROUBLESHOOTING

Symptom	Common Cause
Fixture does not illuminate	<ul style="list-style-type: none"> <li>• Incorrect wiring. Polarity of Low Voltage V+ and V- are reversed.</li> <li>• Circuit breaker is OFF or tripped.</li> </ul>
<ul style="list-style-type: none"> <li>• Different fixtures do not dim in sync.</li> <li>• Fixture turns off at low dim level.</li> <li>• Fixture strobos/flickers at low dim level.</li> <li>• Dimmer buzzes excessively</li> </ul>	<ul style="list-style-type: none"> <li>• Only install 24 VDC fixtures on the compatibility list.</li> </ul>
Fixture heats up excessively	<ul style="list-style-type: none"> <li>• Incorrect voltage pairing of dimmer and fixture.</li> <li>• Do not attach a 12V fixture to a 24V dimmer.</li> <li>• Fixture is not compatible.</li> </ul>

#### WAC Lighting

www.waclighting.com  
Phone (800) 526.2588 • Fax (800) 526.2585

#### Headquarters/Eastern Distribution Center

44 Harbor Park Drive • Port Washington, NY 11050  
Phone (516) 515.5000 • Fax (516) 515.5050

#### Western Distribution Center

1750 Archibald Avenue • Ontario, CA 91760  
Phone (800) 526.2588 • Fax (800) 526.2585

## VOLTAGE DROP CHARTS

For best performance and lumen output, ensure proper wire gauge is installed to compensate for voltage drop of low voltage circuits.

**1** Determine load size. Let's assume load is 55 W. Round up to nearest load.

**2** Determine distance from WAC Dimmer + Driver to load. Let's assume the distance is 36 ft.

**3** Drop down from the load to the distance and go to the left on the chart to see the recommended wire gauge. In this example, it is recommended to use 16 AWG.

### 24V Voltage Drop & Wire Length Distance Chart

Wire Gauge	10 W .42 A	20 W .83 A	30 W 1.3 A	40 W 1.7 A	50 W 2.1 A	60 W 2.5 A	70 W 2.9 A	80 W 3.3 A	100 W 4.2 A
18 AWG	134 ft.	68 ft.	45 ft.	33 ft.	27 ft.	22 ft.	19 ft.	17 ft.	14 ft.
16 AWG	215 ft.	109 ft.	72 ft.	54 ft.	43 ft.	36 ft.	31 ft.	27 ft.	22 ft.
14 AWG	345 ft.	174 ft.	115 ft.	86 ft.	69 ft.	57 ft.	49 ft.	43 ft.	36 ft.
12 AWG	539 ft.	272 ft.	181 ft.	135 ft.	108 ft.	90 ft.	77 ft.	68 ft.	56 ft.
10 AWG	784 ft.	397 ft.	263 ft.	197 ft.	158 ft.	131 ft.	112 ft.	98 ft.	82 ft.

## VOLTAGE ADJUSTMENT

WAC Dimmer + Driver can provide a 1V boost if the fixture is receiving noticeable light degradation.

- Pop off face plate as shown in Step 4 of INSTALLATION.
- Use a small screwdriver to adjust output voltage by turning adjustment dial clockwise.

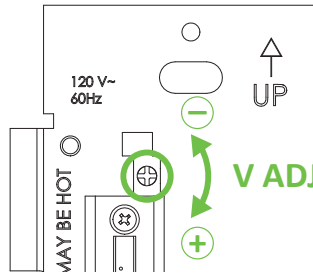

### WAC Lighting

www.waclighting.com  
Phone (800) 526.2588 • Fax (800) 526.2585

### Headquarters/Eastern Distribution Center

44 Harbor Park Drive • Port Washington, NY 11050  
Phone (516) 515.5000 • Fax (516) 515.5050

### Western Distribution Center

1750 Archibald Avenue • Ontario, CA 91760  
Phone (800) 526.2588 • Fax (800) 526.2585