

WAC LIGHTING

007LED

Low Voltage Track Luminaire

System Type & Voltage	Model & Wattage	Finish
-HHT H Track - 120 VAC	007LED 8W	BK Black
-JHT J/J2 Track - 120 VAC		BN Brushed Nickel
-LHT L Track - 120 VAC		WT White

Example: **HHT-007LED-BK**

DESCRIPTION

Low Voltage track fixture offered in a wide variety of styles and finishes for a multitude of lighting applications in residential, retail, commercial and hospitality environments. Available in H, J/J2, and L style track configurations. Built-in transformer has a 1W minimum load and can be installed with an LED lamp.

FEATURES

- Available with LED lamp option
- Swivel yoke for easy aiming
- 350° horizontal rotation and 90° vertical tilt
- Available Framing Projector accessory (order separately)
- Clear lens included (Halogen version)
- LED model includes 8W MR16 LED lamp
- Warranty: 5 year, 3 year LED lamp
- Transformer concealed within the fixture

SPECIFICATIONS

Construction:	Die-cast aluminum track head with polycarbonate transformer case and track adapter. Bi-pin ceramic socket for MR16 lamp.
Power:	8W
Input:	120 VAC, 50/60Hz
Dimming:	ELV: 100-15%
Light Source:	LED MR16 (Included) 3 Step Mac Adam Ellipse
Rated Life:	25000 Hours
Finish:	Electrostatically powder Coated White, Electroplated Brushed Nickel, Electrostatically powder Coated Black
Operating Temp:	-4°F to 104°F (-20°C to 40°C)
Standards:	UL, cUL, Dry Location Listed



FINISHES

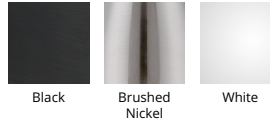

LINE DRAWING

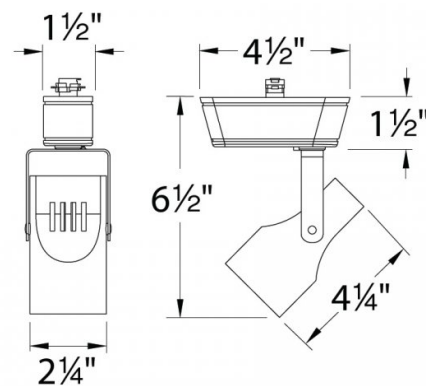

Fixture Type: _____

Catalog Number: _____

Project: _____

Location: _____

Fixture Type: _____

Catalog Number: _____







Project: _____

Location: _____

007LED

Low Voltage Track Luminaire

ACCESSORIES

	<i>Model</i>	<i>Description</i>	<i>Finish</i>
	LENS-16-AMB LENS-16-BLU LENS-16-GRN LENS-16-RED	<i>Colored Lens</i> <i>Colored Lens</i> <i>Colored Lens</i> <i>Colored Lens</i>	<i>Amber</i> <i>Blue</i> <i>Green</i> <i>Red</i>
	LENS-16-FR	<i>Clear/Frosted Lens</i>	<i>Frosted</i>
	LENS-16-SPR	<i>Spread Lens</i>	<i>Spread Lens</i>
	LENS-16-UVF	<i>UV Filter lens</i>	<i>Clear</i>
	LENS-16-BEL	<i>Beam Elongating Lens</i>	<i>Beam Elongating</i>
	LENS-16-HCL	<i>Honeycomb Louver</i>	<i>Black</i>
	008FP-WT 008FP-BK	<i>Framing Projector</i> <i>Accessory</i> <i>Framing Projector</i> <i>Accessory</i>	<i>White</i> <i>Black</i>