

W Track System - Surface Mount

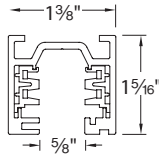

Fixture Type:

Catalog Number:

Project:

Location:

PRODUCT DESCRIPTION

Heavy duty architectural grade track with two independently controllable circuits. Stem or cable suspensions available.

FEATURES

- Power per Circuit: 1920W max (120V) , 4432W max (277V)
- Operating Current: Each circuit is rated 20A (2 x 20A = 40A max)
- Extruded aluminum construction
- UL & CUL listed
- 5 year WAC Lighting product warranty

SPECIFICATIONS

Materials: Solid copper alloy bus bars in an extruded aluminum with a rectangular cross-sectional area of 4.2 mm²

Electrical: Electric feed capability through all jointers/feeders (except Power Connector and Flexible Connector) using standard 1/2 inch knock-outs

Mounting: Fixtures may be installed or removed anywhere along the track. Minimum fixture spacing is 1 foot. Track fixture has safety interlocks when installed/removed. Polarization is guaranteed throughout the system

Finish: Available in black powder coat (**BK**), white powder coat (**WT**), or platinum anodized (**PT**) finishes

Standards: UL & CUL listed

ORDER NUMBER

Model	Length	Finish
WT 120V	4 4'	BK Black
WHT 277V	8 8'	PT Platinum
	12 12'	WT White

Each section includes two matching end caps.



Example: **WHT4-PT**











wacighting.com
Phone (800) 526.2588
Fax (800) 526.2585



Headquarters/Eastern Distribution Center
44 Harbor Park Drive
Port Washington, NY 11050









Central Distribution Center
1600 Distribution Ct
Lithia Springs, GA 30122







Western Distribution Center
1750 Archibald Avenue
Ontario, CA 91760

W Track System - Surface Mount

Accessories	Model	Volt	Finish	Description
Live End Connector – Left Polarity 	WEDL WHEDL	120V 277V	BK PT WT	Direct wiring through ceiling. Polarity on left side of track.
Live End Connector – Right Polarity 	WEDR WHEDR	120V 277V	BK PT WT	Direct wiring through ceiling. Polarity on right side of track.
"I" Connector 	WPC WHPC	120V 277V	BK PT WT	Join two sections of track with electrical continuity.
"I" Power Connector 	WIC WHIC	120V 277V	BK PT WT	Power entry point at the connection of two tracks.
Flexible Connector 	WFC WHFC	120V 277V	BK PT WT	Transition from wall-to-wall, wall-to-ceiling, or ceiling-to-ceiling. Power feedable.
Canopy Plate 	CP	120V 277V	BK PT WT	Covers a standard 4" octagonal box.
"L" Connector Left Polarity 	WLLC WHLLC	120V 277V	BK PT WT	Join 2 track sections to make power feedable 90° left polarity turns.
"L" Connector Right Polarity 	WRLC WHRLC	120V 277V	BK PT WT	Join 2 track sections to make power feedable 90° right polarity turns.
"T" Connector – Left 	WLTC WHLTC	120V 277V	BK PT WT	Join 3 track sections. Power feedable. Polarity on outside edge.
"T" Connector – Right 	WRTC WHRTC	120V 277V	BK PT WT	Join 3 track sections. Power feedable. Polarity on inside edge.
"X" Connector 	WXC WHXC	120V 277V	BK PT WT	Join 4 track sections. Power feedable.

Track Current Limiter	Model	Volt	Rating	Finish	Description
Live end - Left 	WEDL WHEDL	120V 277V	1A 1 Amp 2A 2.5Amp 5A 5 Amp 7A 7.5Amp 10A 10Amp 12A 12Amp	BK PT WT	Assures compliance to California Title 24 or ASHRAE 90.1 requirements
Live end - Right 	WEDR WHEDR	120V 277V			

Suspension	Model	Length	Finish	Description
Stem Kit With Power Feed 	WMSP	6 6" 12 12" 24 24" 36 36" 48 48" 96 96"	BK PT WT	Power feed to connect with a Live End or any Joiner/Feeder. May be field cut.
Flexible Power Feed 	WMFP	48 48" 96 96"	BK PT WT	Flexible power feed to connect with a Live End or any Joiner/Feeder. Recommended for use with Cable Suspensions. May be field cut.
Pendant Stem Kit 	WMT-X	6 6" 12 12" 24 24" 36 36" 48 48" 96 96"	BK PT WT	Use to extend track from the ceiling. May be field cut.
T-Bar Stem Kit 	WMT-TB			Extend track from drop ceilings. May be field cut.
Sloped Ceiling Stem Kit 	WMT	XS6 6" XS12 12" XS24 24" XS36 36" XS48 48" XS96 96"	BK PT WT	Use to extend track from a sloped ceiling. May be field cut.
Sloped Ceiling Cable Kit 	WMST	XS48 48" XS96 96"	BK PT WT	Extend track from a sloped ceiling. May be field cut.
Suspension Cable Kit 	WMST-X	48 48" 96 96"	BK PT WT	Extend track from the ceiling. May be field cut.
T-Bar Suspension Cable Kit 	WMST-TB			Extend track from drop ceilings. May be field cut.

Suspension Accessories	Model	Finish
Suspension Hanger Clip 	WMT	BK PT WT
"I" Power Connector Suspension Mount 	WMPC	BK PT WT
Live End Suspension Mount 	WMED	BK PT WT
Power Feed Coupler Suspension Mount Use with "I" Power Connector 	WMIC	BK PT WT
"L" Connector Suspension Mount 	WMLC	BK PT WT
"T" Connector Suspension Mount 	WMTC	BK PT WT
"X" Connector Suspension Mount 	WMXC	BK PT WT

wacighting.com
Phone (800) 526.2588
Fax (800) 526.2585

Headquarters/Eastern Distribution Center
44 Harbor Park Drive
Port Washington, NY 11050

Central Distribution Center
1600 Distribution Ct
Lithia Springs, GA 30122

Western Distribution Center
1750 Archibald Avenue
Ontario, CA 91760

Straight Configuration

- A WEDR** Live end connector (right)
- B WIC** I power connector
- C WPC** I connector
- D WEC** End cap

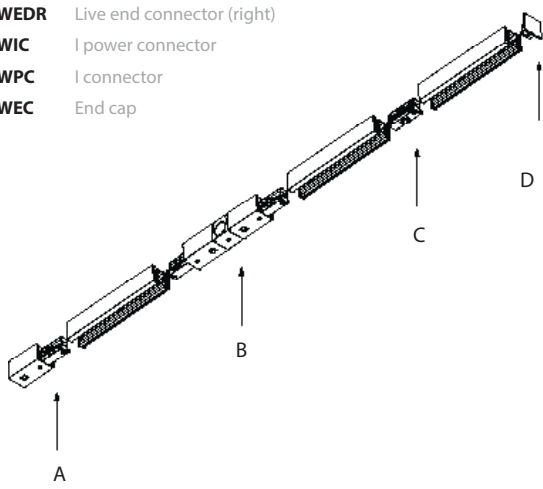

Flexible Configurations

- A WEDR** Live end connector (right)
- B WEDL** Live end connector (left)
- C WFC** Flexible connector
- D WEC** End cap

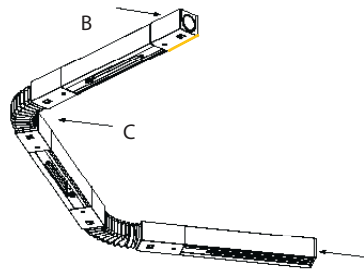

Horizontal Ceiling Mount

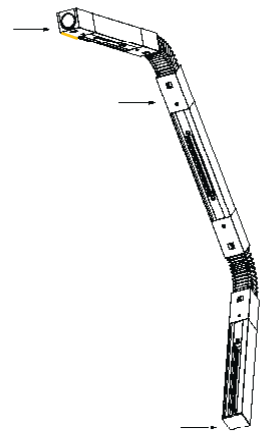

Vertical Wall-to-Ceiling Mount

Grid Configuration

- A WLLC** L Connector Left
- B WLTC** T Connector Left
- C WRTC** T Connector Right
- D WXC** X Connector

= Indicates Electrical Continuity

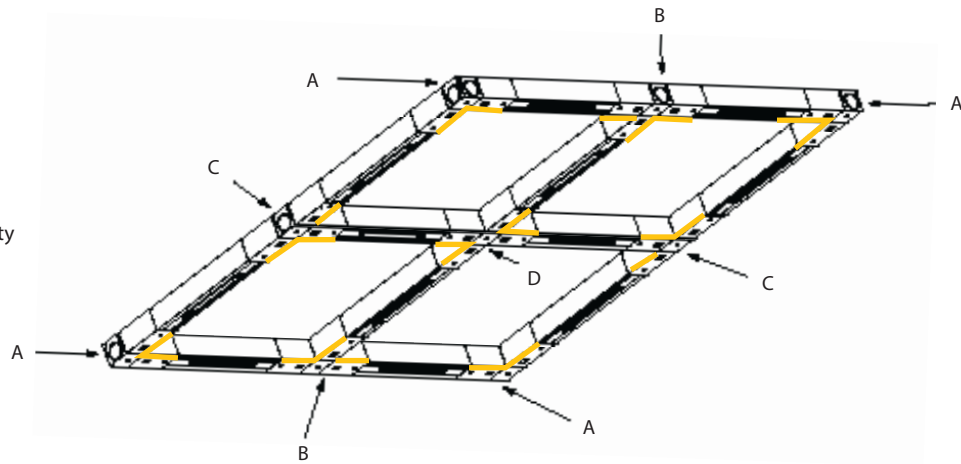

Cable Suspension Mount

- A WMFP** Flexible Stem kit with power feed
- B WMED** Live end suspension mount
- C WEDL** Live end connector (left)
- D WMST-X** Cable suspension kit
- E WMT** Suspension hanger clip
- F WMST-TB** T bar cable suspension kit
- G WMST-XS** Sloped ceiling cable kit
- H WMLC** L connector suspension mount
- I WLLC** L connector left
- J WEC** End cap

Use one support for every 4 feet

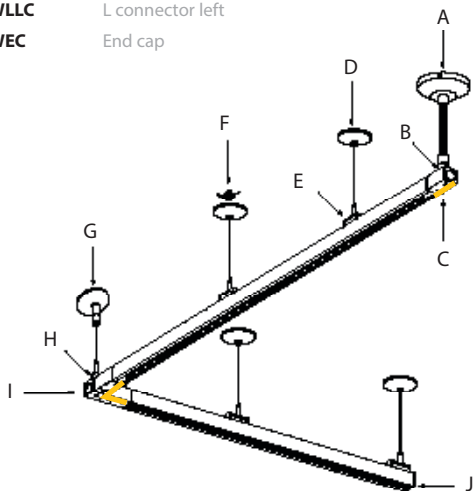

Stem Suspension Mount

- A WMSP** Stem kit with power feed
- B WMED** Live end suspension mount
- C WEDR** Live end connector (right)
- D WMT-XS** Sloped ceiling stem kit
- E WMT** Suspension hanger clip
- F WMT-TB** T bar stem kit
- G WMT-X** Stem kit
- H WMLC** L connector suspension mount
- I WLLC** L connector left
- J WEC** End cap

