

INSTALLATION INSTRUCTION

WAC LIGHTING

Responsible Lighting®

H/L/J-8020

WARNING

IMPORTANT: NEVER attempt any work without shutting off the electricity.

- Read all instructions before installing.
- System is intended for installation by a qualified electrician in accordance with the National Electrical Code and local regulations.
- Go to the main fuse box, or circuit breaker. Place the main power switch in the "OFF" position and unscrew the fuse(s) or switch "OFF" the circuit breaker switch(es) that control the power to the fixture or room that you are working on.
- Place the wall switch in the "OFF" position.

AVERTISSEMENT

IMPORTANT : Coupez l'électricité avant TOUTE manipulation.

- Lisez toutes les instructions avant d'installer.
- Système est destiné à être installé par un électricien qualifié en conformité avec le code national de l'électricité et les règlements locaux.
- Accédez au panneau central de disjoncteurs ou de fusibles de votre demeure et placez l'interrupteur principal en position d'arrêt (« OFF »).
- Placez l'interrupteur mural en position d'arrêt (« OFF »).

OVERVIEW:

Fixtures are designed for use on WAC Lighting's track systems.

LED TRACK LUMINAIRE	TRACK SYSTEM
H-8020 Series	120V HTrack
L-8020 Series	120V L Track
J-8020 Series	120V J or J2 Track

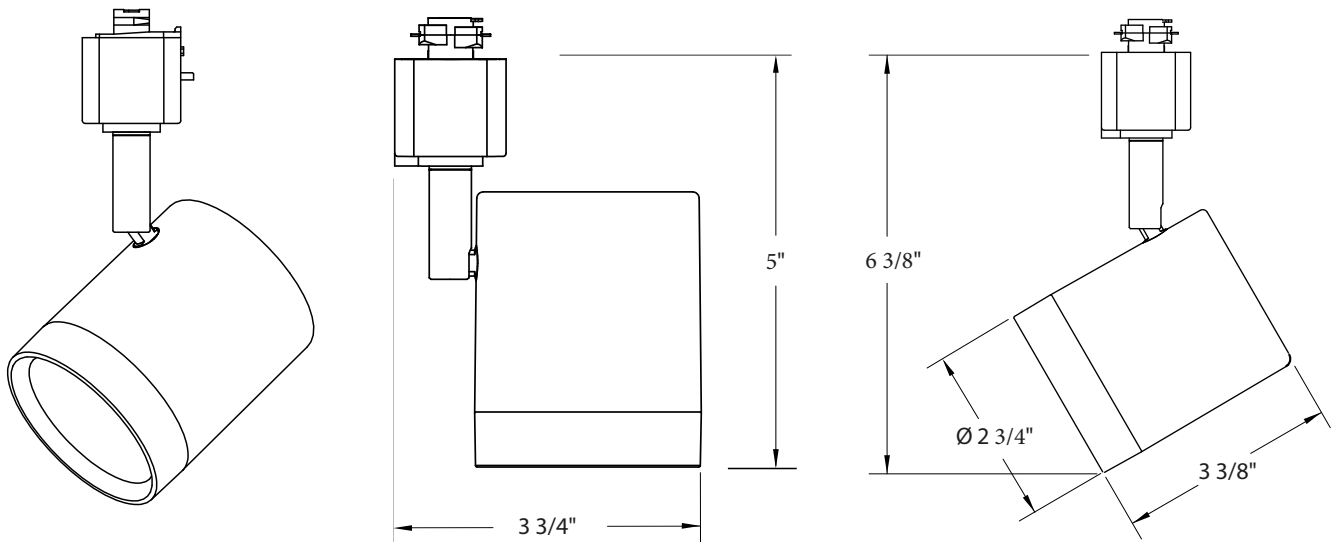

Note: All parts must be used as indicated in these instructions. Do not substitute any parts, leave parts out, or use any parts that are worn out or broken. Failure to follow this instruction could invalidate the ETL/cETL listing of this fixture.

waclighting.com
Phone (800) 526.2588
Fax (800) 526.2585

Headquarters/Eastern Distribution Center
44 Harbor Park Drive
Port Washington, NY 11050

Central Distribution Center
1600 Distribution Ct
Lithia Springs, GA 30122

Western Distribution Center
1750 Archibald Avenue
Ontario, CA 91760



H/L/J-8020

FIXTURE INSTALLATION FOR H/ L/ J TRACK: (Fig.1)

1. The track has a groove running its length to indicate polarity and the track adapter locking tab has an arrow indicating locking direction.
2. Insert adapter into track slot.
For H/J Track: The arrow should be on the grooved side of the track.
For L Track: The arrow should be on the side opposite the grooved side of the track.
3. Push up and rotate the adapter into the lock position.
4. Reverse procedure to remove. The fixture may be positioned anywhere along the track.

Fig.1

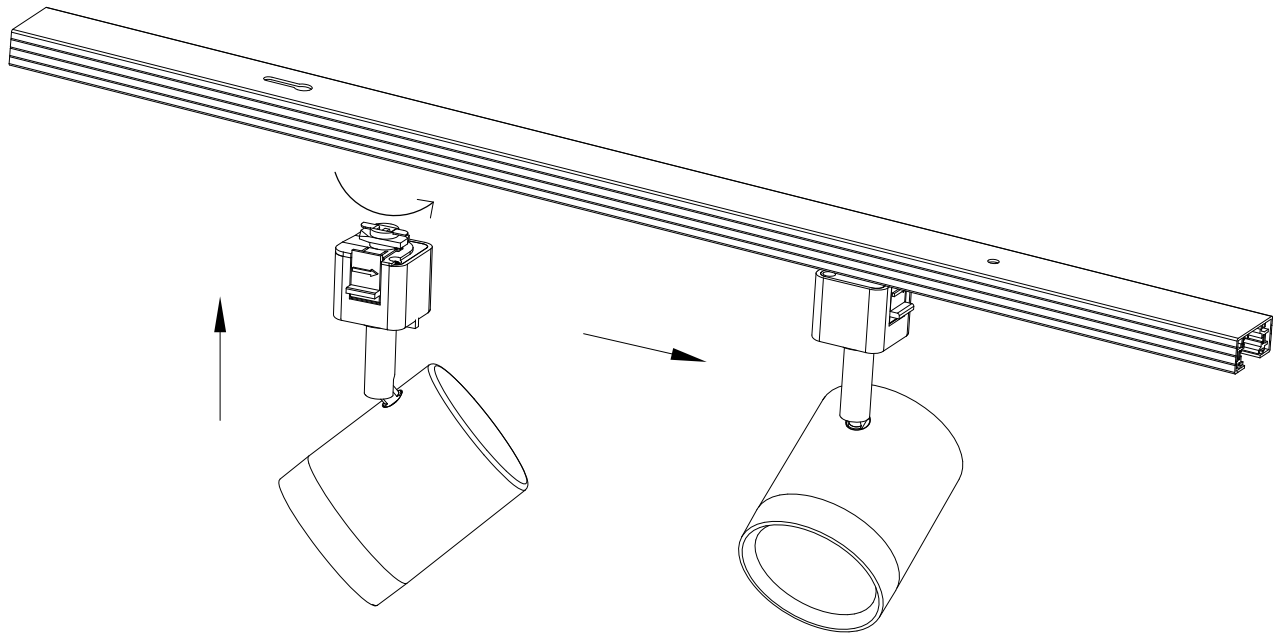

FIXTURE POSITIONING: (Fig.2)

Power on fixture, rotate the luminaire's body horizontally or vertically to aim it properly.

The fixture can rotate $\pm 90^\circ$ vertically and 350° horizontally.

Fig.2

