

**SAFETY INSTRUCTION**

**IMPORTANT:** NEVER attempt any work without shutting off the electricity.

- Always turn off power at fuse box prior to installation to prevent electrical shock.
- Intended for indoor use. Dry and damp locations.
- For installation and serviced by a qualified, licensed electrician.
- Install in accordance with national electric code, and local regulations.
- Consult with local inspector to assure compliance.
- Do not submerge, or install within 5 feet of a swimming pool.
- Do not connect the tape directly to high voltage power
- Do not exceed maximum run recommended for each tape series

**CAUTION – TO REDUCE RISK OF FIRE AND ELECTRICAL SHOCK**

- Read all instructions before installing.
- Handle product with care.
- Do not conceal or extend exposed conductors through a building wall
- To reduce the risk of fire and burns, do not install this lighting system where the exposed bare conductors can be shorted or contact any conductive materials
- To reduce the risk of overheating and potential fire risk, make sure all connections are tight.
- Do not install any fixture assembly closer than 6 in. from any curtain, or similar combustible material.
- Do not modify or disassemble product beyond instructions or warranty will be void.
- Failure to follow safety warnings, and installation instruction will void the warranty

**ATTENTION - AFIN DE RÉDUIRE LES RISQUES D'INCENDIE ET DE CHOC ÉLECTRIQUE**

- Lire toutes les instructions avant d'installer.
- Manipuler le produit avec soin.
- Ne pas dissimuler et faire passer les conducteurs exposés à travers un mur de bâtiment.
- Afin de réduire les risques d'incendie et de brûlures, ne pas installer ce système d'éclairage là où les conducteurs dénudés peuvent être court-circuités, ou entrer en contact avec des matériaux conducteurs.
- Afin de réduire le risque de surchauffe et d'incendie potentiel, s'assurer que toutes les connexions sont bien serrées.
- Ne pas installer aucun luminaire à moins de 6 pouces d'un rideau ou d'un matériau combustible similaire.
- Ne pas modifier ou démonter le produit au-delà des instructions sous peine d'annuler la garantie.
- Ne pas respecter les avertissements de sécurité et des instructions d'installation annulera la garantie.



Avoid contact with sharp objects



Install on stable clean, dry surface



Do not bend the tape light on a horizontal

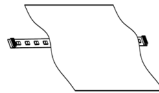

Do not cover LED tape light with any



Do not fold or twist LED Tape

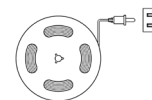

Do not power the LED tape while attached to the spool or tightly coiled

**TROUBLESHOOTING**

- If LED is damaged due to bending, folding, twisting or any sharp object, that LED section may not light up. Damaged LED section can be removed by cutting and reconnecting using Tape to Tape Connector (T24-BS-MM) – Make sure that polarity matches between tapes.

**WIRING AND INSTALLATION:**

1. Turn Power off at circuit breaker

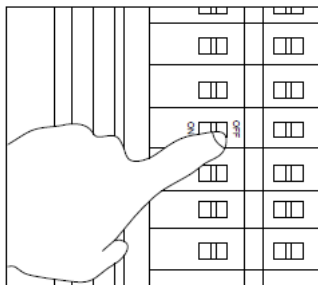

2. Mount Enclosed 24VDC class 2 output remote power supply at desired location. Measure a distance between power supply to the beginning of the tape run and make sure that it is under 25ft.

The maximum allowance distance of wires between the output of power supply and beginning of tape is 25 ft. The minimum output gauge wire of power supply is 20 AWG.

**2.1) Power Supply: PS-24DC-U60R-BT & PS-24DC-U96R-BT**

To extend the cable length between hard wire power supply or a wiring box to a tape sections, an extension cable (T24-BS-EX2-\*) is needed. The extension cable package also provides small screw driver to unscrew the connector.

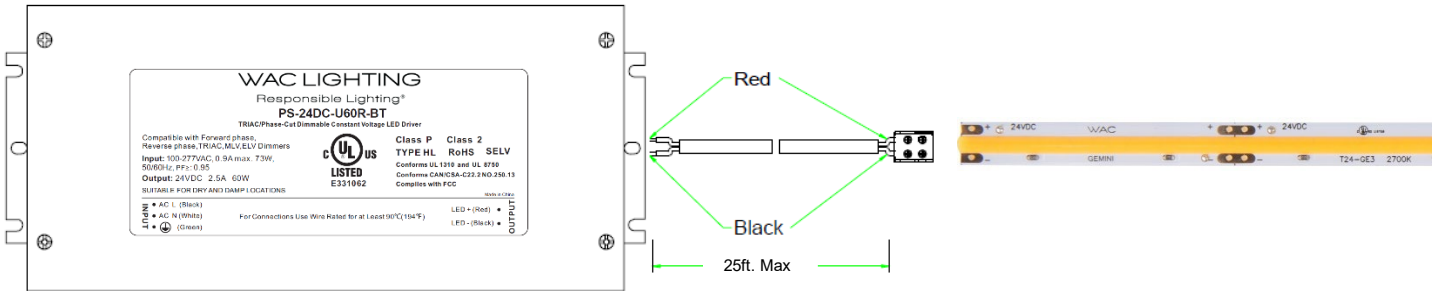

Wire Color		
Power Supply Output	T24-BS-EX2-* Cable	Tape marking
RED	RED	+24VDC
BLACK	BLACK	-

Extension Cable (T24-BS-EX2-\*) and Low Voltage Wiring Box (LED-T-B) can be used to join between wires.

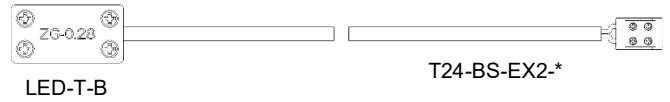

**2.2) Power Supply: EN-BT60-24 & EN-BT96-24**

This power supply has pre-installed output 6ft lead wire. 24VDC Extension Cable (T24-BS-EX2-\*) and Low Voltage Wiring Box (LED-T-B) can be used to join between wires and extend the output lead length.



3. Measure the desired length of tape light and round it off to the nearest 4-inch interval. Determine necessary quantities of other accessories and power supply need for each run. Do not exceed maximum run recommended for each tape series

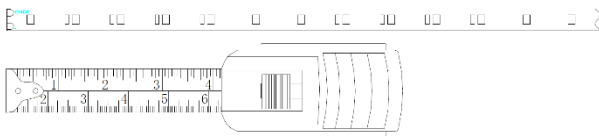

4. If necessary, cut tape light to desired length at line indicated. The tape allows for a cut every 2-inch interval.

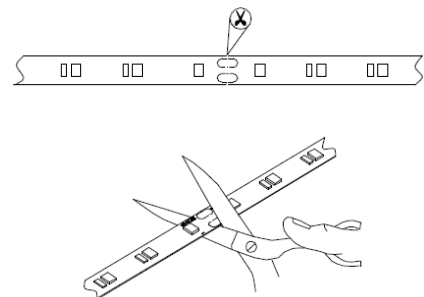

5. Mount Tape Light: Clean surface before mounting. Peel off 3M adhesive backing cover off as strip is installed, pressing firmly to mounting surface in increments.

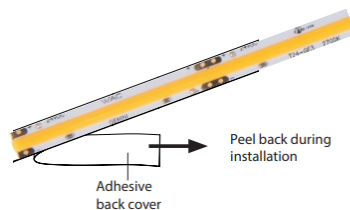

**!** DO NOT peel off installed surface and re-stick

6. Joining between tapes:

Joining tape together (If needed), the following accessories can be used to join between tapes section depending on your application:  
 Tape to Tape Connector (T24-BS-MM) – Making sure that voltage polarity connection is match between tapes.

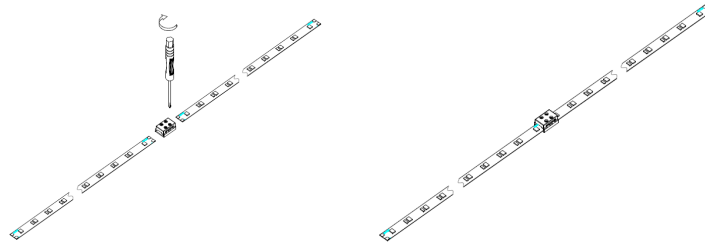

Joiner Cable (T24-BS-IC-\*) can be used to join between tape sections – the wire insulation jacket shall be stripped. Make sure that voltage polarity connection matches between tapes.

Wire Color		
Power Supply Output	T24-BS-IC-* Cable	Tape marking
RED	RED	+24VDC
BLACK	BLACK	-

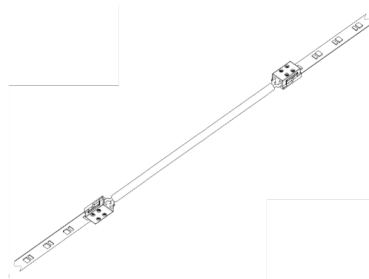

Flex Y Connector (T24-BS-Y) – the wire insulation jacket shall be stripped, Make sure polarity matches between tapes.

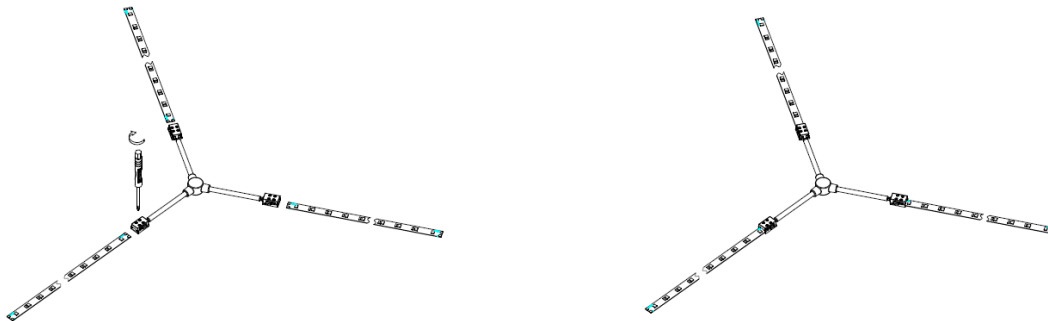

Flex X Connector (T24-BS-X) – the wire insulation jacket shall be stripped, Make sure polarity matches between tapes.

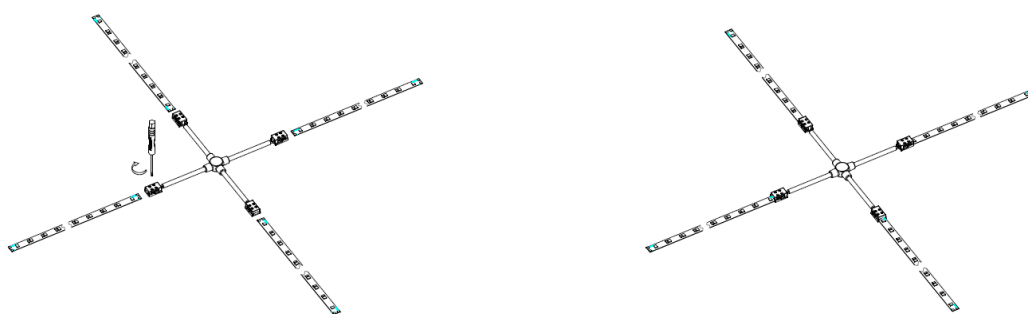

Flex X & Y Connector can be used for power feeding by using low voltage wiring box (LED-T-B).  
 Make sure that polarity is correct.

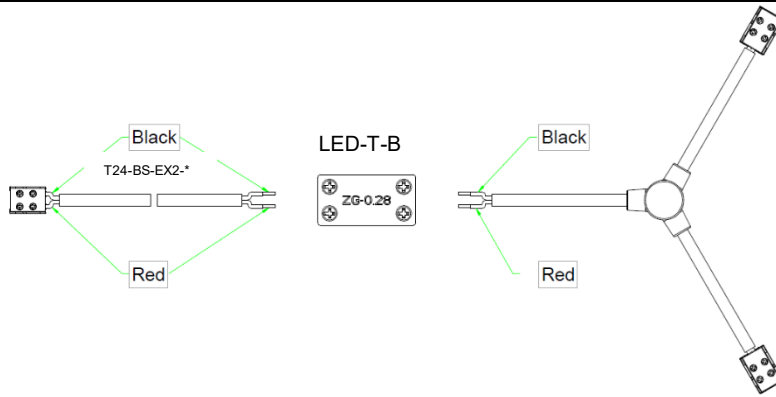

7. Connect electrical power feed wires to Inline Power to Tape Connector (T24-BS-PM) with tape. Make sure that polarity is correct. The wire insulation jacket shall be stripped.

Wire Color		
Power Supply Output	T24-BS-EX2-* Cable	Tape marking
RED	RED	+24VDC
BLACK	BLACK	-



**SYSTEM DIAGRAM:**

**TRIAC / ELV Dimmer Control System: Only PS-24DC-U60R-BT & PS-24DC-U96R-BT**

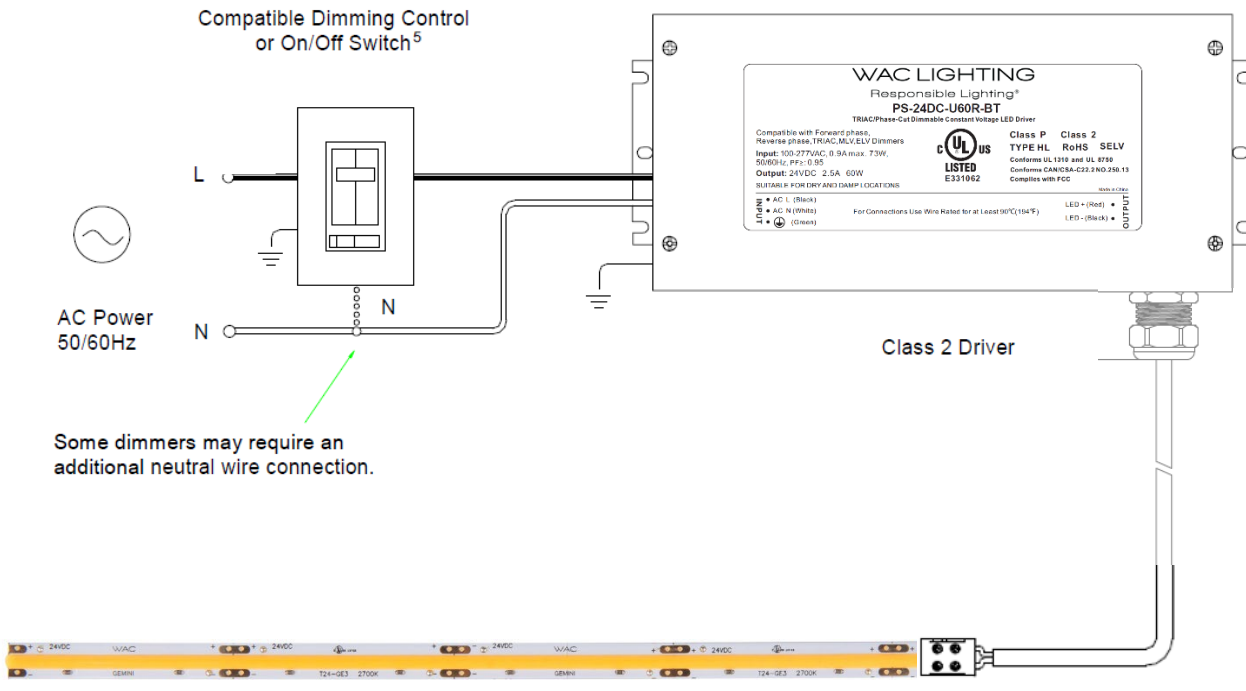

Some dimmers may require an additional neutral wire connection.

**ELV Dimmer Control System**

EN-BT60-24 & EN-BT96-24 can only work with ELV dimmer.

